

Dell Precision M4600/M6600 Mobile Workstation

Setup And Features Information

About Warnings

 **WARNING:** A WARNING indicates a potential for property damage, personal injury, or death.

M4600 — Front And Back View

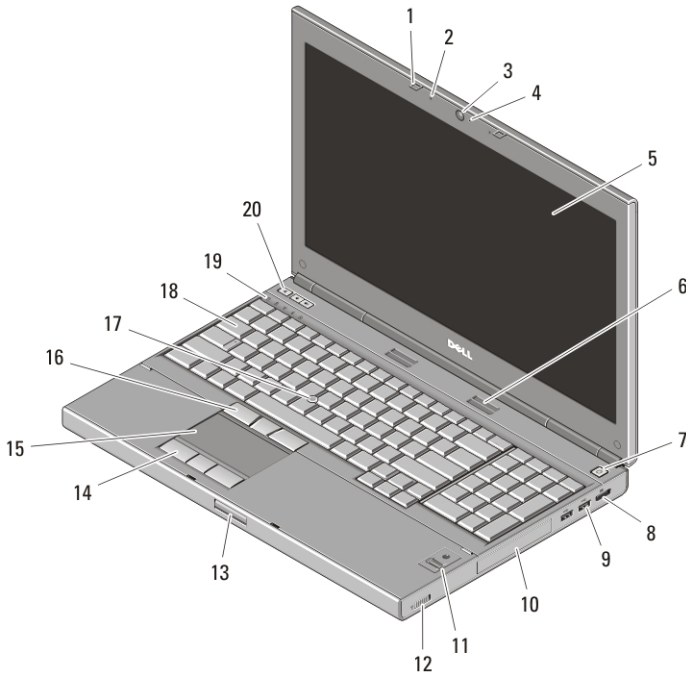

Figure 1. Front View

- | | |
|------------------------|--------------------------|
| 1. display latches (2) | 5. display |
| 2. microphones (2) | 6. speakers (2) |
| 3. camera | 7. power button |
| 4. camera LED | 8. DisplayPort connector |



09HVD7A00

Regulatory Model: P13F, P10E
Regulatory Type: P13F001, P10E001
January 2011

- | | |
|-----------------------------------|-----------------------------|
| 9. USB 3.0 connectors (2) | 15. touchpad |
| 10. hard drive | 16. track stick buttons (3) |
| 11. fingerprint reader (optional) | 17. track stick |
| 12. wireless switch | 18. keyboard |
| 13. display latch release button | 19. device status lights |
| 14. touchpad buttons (3) | 20. volume control buttons |

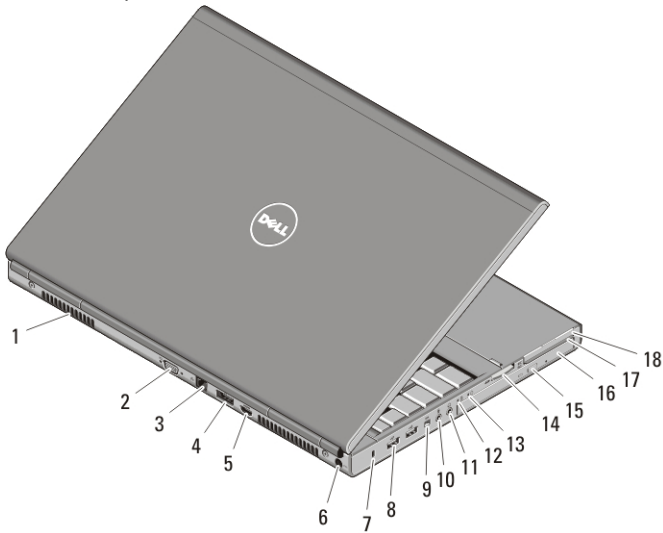

Figure 2. Back View

- | | |
|----------------------------|--------------------------------|
| 1. cooling vents | 10. microphone connector |
| 2. VGA connector | 11. headphone connector |
| 3. network connector | 12. battery status light |
| 4. eSATA/USB 2.0 connector | 13. power light |
| 5. HDMI connector | 14. 8-in-1 card reader slot |
| 6. power connector | 15. optical drive eject button |
| 7. security cable slot | 16. optical drive |
| 8. USB 2.0 connectors (2) | 17. smart card reader slot |
| 9. IEEE 1394 port (4-pin) | 18. ExpressCard slot |

M6600 — Front And Back View

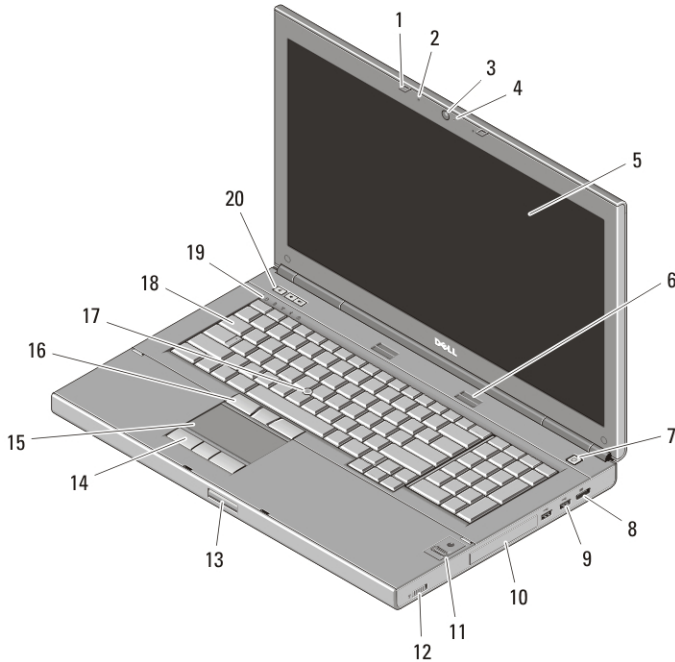

Figure 3. Front View

- | | |
|---------------------------|-----------------------------------|
| 1. display latches (2) | 11. fingerprint reader (optional) |
| 2. microphones (2) | 12. wireless switch |
| 3. camera | 13. display latch release button |
| 4. camera LED | 14. touchpad buttons (3) |
| 5. display | 15. touchpad |
| 6. speakers (2) | 16. track stick buttons (3) |
| 7. power button | 17. track stick |
| 8. DisplayPort connector | 18. keyboard |
| 9. USB 3.0 connectors (2) | 19. device status lights |
| 10. hard drive | 20. volume control buttons |

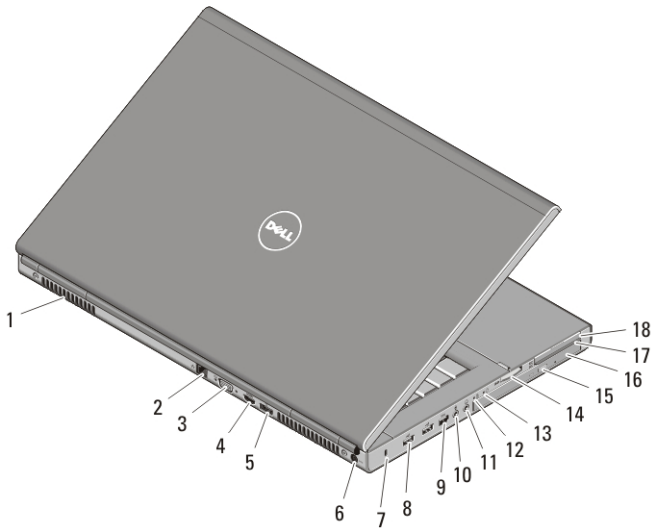

Figure 4. Back View

- | | |
|------------------------------------|--------------------------------|
| 1. cooling vents | 10. microphone connector |
| 2. network connector | 11. headphone connector |
| 3. VGA connector | 12. battery status light |
| 4. HDMI connector | 13. power light |
| 5. eSATA/USB 2.0 connector | 14. 8-in-1 card reader slot |
| 6. power connector | 15. optical drive eject button |
| 7. security cable slot | 16. optical drive |
| 8. USB 2.0 connectors (2) | 17. smart card reader slot |
| 9. IEEE 1394 port (6-pin, powered) | 18. ExpressCard slot |

Quick Setup



WARNING: Before you begin any of the procedures in this section, read the safety information that shipped with your computer. For additional best practices information, see www.dell.com/regulatory_compliance.



WARNING: The AC adapter works with electrical outlets worldwide. However, power connectors and power strips vary among countries. Using an incompatible cable or improperly connecting the cable to the power strip or electrical outlet may cause fire or equipment damage.



CAUTION: When you disconnect the AC adapter cable from the computer, grasp the connector, not the cable itself, and pull firmly but gently to avoid damaging the cable. When you wrap the AC adapter cable, ensure that you follow the angle of the connector on the AC adapter to avoid damaging the cable.



NOTE: Some devices may not be included if you did not order them.

1. Connect the AC adapter to the AC adapter connector on the computer and to the electrical outlet.

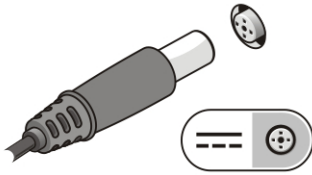

Figure 5. AC Adapter

2. Connect the network cable (optional).

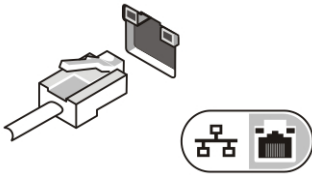

Figure 6. Network Connector

3. Connect USB devices, such as a mouse or keyboard (optional).

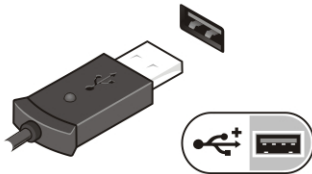

Figure 7. USB Connector

4. Connect IEEE 1394 devices, such as a 1394 hard drive (optional).

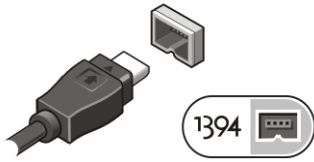

Figure 8. 1394 Connector on M4600

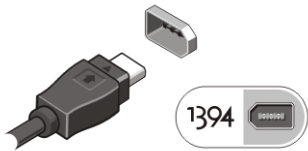

Figure 9. 1394 Connector on M6600

5. Open the computer display and press the power button to turn on the computer.

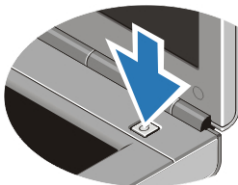



Figure 10. Power Button

 **NOTE:** It is recommended that you turn on and shut down your computer at least once before you install any cards or connect the computer to a docking device or other external device, such as a printer.

Specifications

 **NOTE:** Offerings may vary by region. The following specifications are only those required by law to ship with your computer. For more information regarding the configuration of your computer, click **Start** → **Help and Support** and select the option to view information about your computer.

System Information

Chipset	Mobile Intel QM67 Express Chipset
Processor	<ul style="list-style-type: none">• Intel Core i5 and i7 Dual Core• Intel Core i7 Quad Extreme• Intel Core i7 Quad Core

Video

Video type	discrete
Data bus	integrated video
Video controller and memory	
M4600	<ul style="list-style-type: none">• AMD FirePro M5950 Mobility Pro Graphics with 1 GB GDDR5• NVIDIA Quadro 1000M with 2 GB GDDR3• NVIDIA Quadro 2000M with 2 GB GDDR3
M6600	<ul style="list-style-type: none">• AMD FirePro M8900 Mobility Pro Graphics with 2 GB GDDR5• NVIDIA Quadro 3000M with 2 GB GDDR5• NVIDIA Quadro 4000M with 2 GB GDDR5• NVIDIA Quadro 5010M with 4GB GDDR5

Memory

Memory connectors	
Intel Core i5 and i7 Dual Core processors	two DIMM slots
Intel Core i7 Quad Core and i7 Quad Extreme processors	four DIMM slots
Memory capacity	1 GB, 2 GB, 4 GB, and 8 GB
Memory type	DDR3 1333 MHz and 1600 MHz (faster UI)
Minimum memory	2 GB
Maximum memory	
Intel Core i5 and i7 Dual Core processors	16 GB
Intel Core i7 Quad Core and i7 Quad Extreme processors	32 GB

Battery

Type	lithium ion
Dimensions (6-cell / 9-cell / 9-cell long cycle life (LCL)):	

Battery



NOTE: The Dell Precision M6600 Mobile Workstation only supports a 9-cell battery.

Depth	80 mm (3.14 inches)
Height	190 mm (7.48 inches)
Width	20 mm (0.78 inches)
Weight	365 g (0.80 lb) (6-cell) 500 g (1.10 lb) (9-cell / 9-cell LCL)
Voltage	11.10 V
Temperature range:	
Operating	0 °C to 35 °C (32 °F to 95 °F)
Non-operating	-40 °C to 65 °C (-40 °F to 149 °F)
Coin-cell battery	3 V CR2032 lithium ion cell

AC Adapter	M4600	M6600
Input voltage	100 VAC to 240 VAC	100 VAC to 240 VAC
Input current (maximum)	2.50 A	3.50 A
Input frequency	50 Hz to 60 Hz	50 Hz to 60 Hz
Output power	180 W	240 W
Output current	9.23 A	12.30 A
Rated output voltage	19.50 VDC	19.50 VDC
Dimensions:	180 W	240 W
Height	30 mm (1.18 inches)	25.40 mm (1 inch)
Width	155 mm (6.10 inches)	200 mm (7.87 inches)
Depth	76 mm (2.99 inches)	100 mm (3.93 inches)
Temperature range:		
Operating	0 °C to 40 °C (32 °F to 104 °F)	

AC Adapter	M4600	M6600
Non Operating	-40 °C to 65 °C (-40 °F to 149 °F)	

Contactless Smart Card

Supported Smart Cards and Technologies	ISO14443A — 160 kbps, 212 kbps, 424 kbps, and 848 kbps
	ISO14443B — 160 kbps, 212 kbps, 424 kbps, and 848 kbps
	ISO15693
	HID iClass
	FIPS201
	NXP Desfire

Physical	M4600	M6600
Height	36.5 mm (1.44 inches)	37.20 mm (1.46 inches)
Width	376 mm (14.80 inches)	416.70 mm (16.41 inches)
Depth	256 mm (10.08 inches)	270.60 mm (10.65 inches)
Weight (Minimum)	2.87 kg (6.33 lb with 6-cell battery and airbay)	3.42 kg (7.53 lb with 6-cell battery and airbay)

Environmental

Temperature:

Operating	0 °C to 35 °C (32 °F to 95 °F)
Storage	-40 °C to 65 °C (-40 °F to 149 °F)

Relative humidity (maximum):

Operating	10 % to 90 % (noncondensing)
Storage	5 % to 95% (noncondensing)

Airborne contaminant level

G2 or lower as defined by ISA-S71.04-1985

Altitude (maximum):

Operating	-15.2 m to 3048 m (-50 ft to 10,000 ft)
-----------	---

Environmental

Non-operating

-15.2 m to 10,668 m (-50 ft to 35,000 ft)

Finding More Information and Resources

See the safety and regulatory documents that shipped with your computer and the regulatory compliance website at www.dell.com/regulatory_compliance for more information on:

- Safety best practices
- Regulatory certification
- Ergonomics

See www.dell.com for additional information on:

- Warranty
- Terms and Conditions (U.S. only)
- End User License Agreement

Information in this publication is subject to change without notice.

© 2010 Dell Inc. All rights reserved.

Reproduction of these materials in any manner whatsoever without the written permission of Dell Inc. is strictly forbidden.

Trademarks used in this text: Dell™, the DELL logo, Dell Precision™, Precision ON™, ExpressCharge™, Latitude™, Latitude ON™, OptiPlex™, Vostro™, and Wi-Fi Catcher™ are trademarks of Dell Inc. Intel®, Pentium®, Xeon®, Core™, Atom™, Centrino®, and Celeron® are registered trademarks or trademarks of Intel Corporation in the U.S. and other countries. AMD® is a registered trademark and AMD Opteron™, AMD Phenom™, AMD Sempron™, AMD Athlon™, ATI Radeon™, and ATI FirePro™ are trademarks of Advanced Micro Devices, Inc. Microsoft®, Windows®, MS-DOS®, Windows Vista®, the Windows Vista start button, and Office Outlook® are either trademarks or registered trademarks of Microsoft Corporation in the United States and/or other countries. Blu-ray Disc™ is a trademark owned by the Blu-ray Disc Association (BDA) and licensed for use on discs and players. The Bluetooth® word mark is a registered trademark and owned by the Bluetooth® SIG, Inc. and any use of such mark by Dell Inc. is under license. Wi-Fi® is a registered trademark of Wireless Ethernet Compatibility Alliance, Inc.

Other trademarks and trade names may be used in this publication to refer to either the entities claiming the marks and names or their products, Dell Inc. disclaims any proprietary interest in trademarks and trade names other than its own.